

Las Virtudes de San José

Actividades

didácticas

para niños



Encuentra en la sopa de letras siete virtudes de San José, mismas que podemos poner en práctica en nuestra vida diaria.

B	T	T	Y	O	B	E	D	I	E	N	T	E	A	J	S	O	P	A	D
V	X	X	J	H	N	J	V	Ñ	L	O	S	J	A	L	Ñ	P	S	L	M
L	N	N	A	S	B	R	A	L	Y	H	L	S	R	R	O	L	F	W	A
Z	Ñ	P	T	B	C	D	E	F	A	G	H	S	E	S	U	S	K	C	X
P	L	R	A	R	L	Ñ	I	I	L	L	I	A	U	M	O	Y	H	Q	A
L	P	O	D	G	A	R	O	S	T	A	U	N	S	S	A	S	N	I	B
Ñ	P	T	S	A	R	B	O	R	E	S	W	J	S	Q	V	A	A	O	V
M	I	E	W	L	M	A	A	L	P	A	T	O	A	N	O	F	E	P	C
N	U	C	A	M	S	B	R	J	O	C	O	S	U	G	A	L	E	Z	D
J	T	T	J	X	A	T	Y	I	A	E	R	E	U	L	E	O	J	X	E
A	R	O	V	J	O	H	J	M	A	D	L	D	W	O	D	A	F	C	F
O	E	R	A	P	M	O	S	N	E	T	O	S	O	R	O	M	A	V	G
S	L	L	G	Ñ	A	P	R	O	T	E	C	R	S	L	N	Ñ	X	B	H
A	S	S	Z	E	G	R	O	L	E	I	F	A	M	R	T	Q	W	G	I
Q	O	O	S	O	M	T	A	Y	L	W	I	D	L	O	E	W	A	F	J
I	M	A	Q	L	V	A	L	I	E	N	T	E	A	R	I	D	E	D	Y
A	A	A	S	W	J	K	L	O	P	T	R	A	R	K	L	Ñ	B	A	J



San José:

Padre en la Ternura

Colorea.

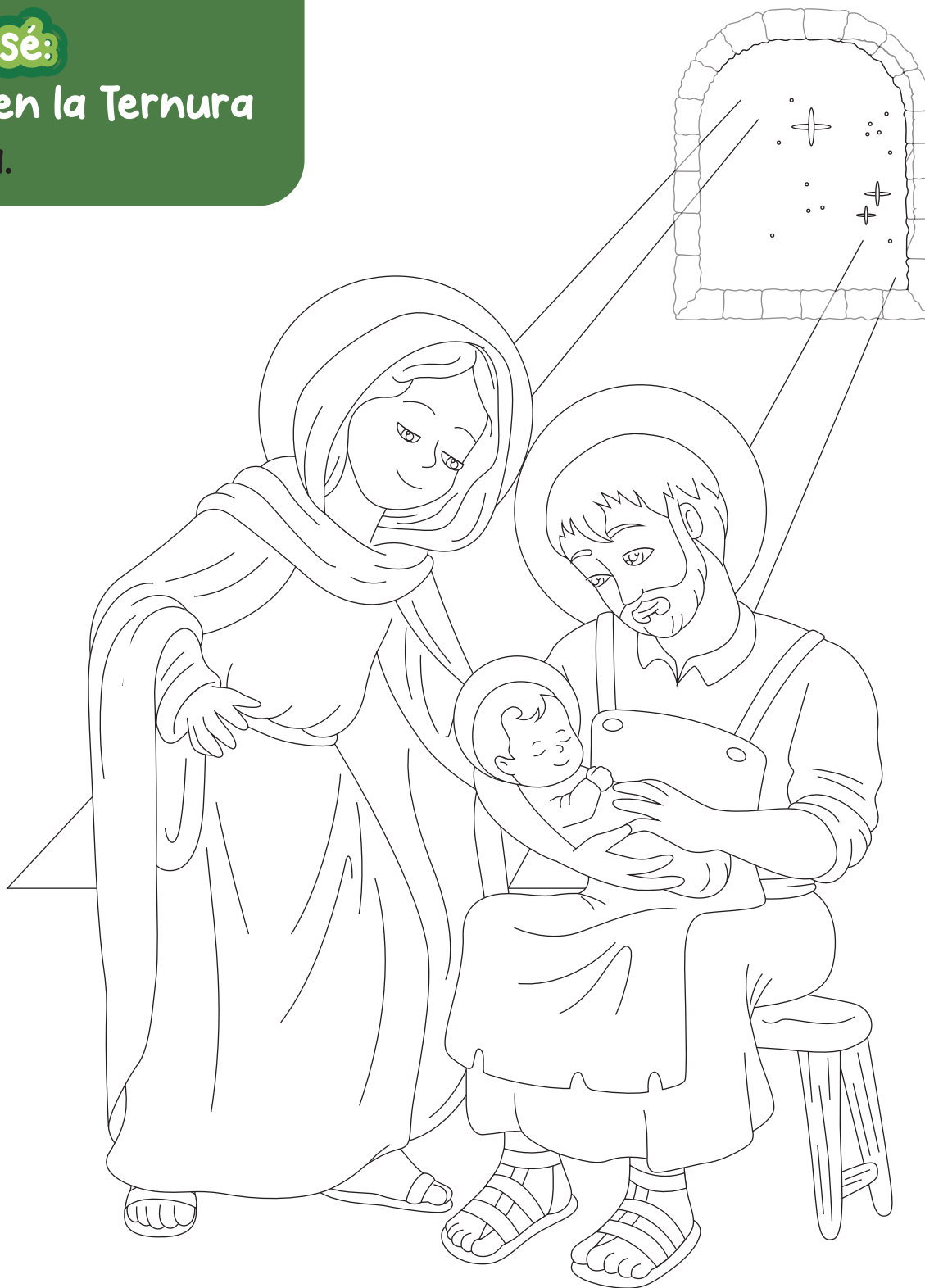

**Jesús vio la ternura de Dios en José: «Como un padre siente ternura por sus hijos, así el Señor siente ternura por quienes lo temen»
(Sal 103.13). (PC 2)**





San José: Padre Protector

Encuentra el camino para que el niño Jesús llegue a San José.

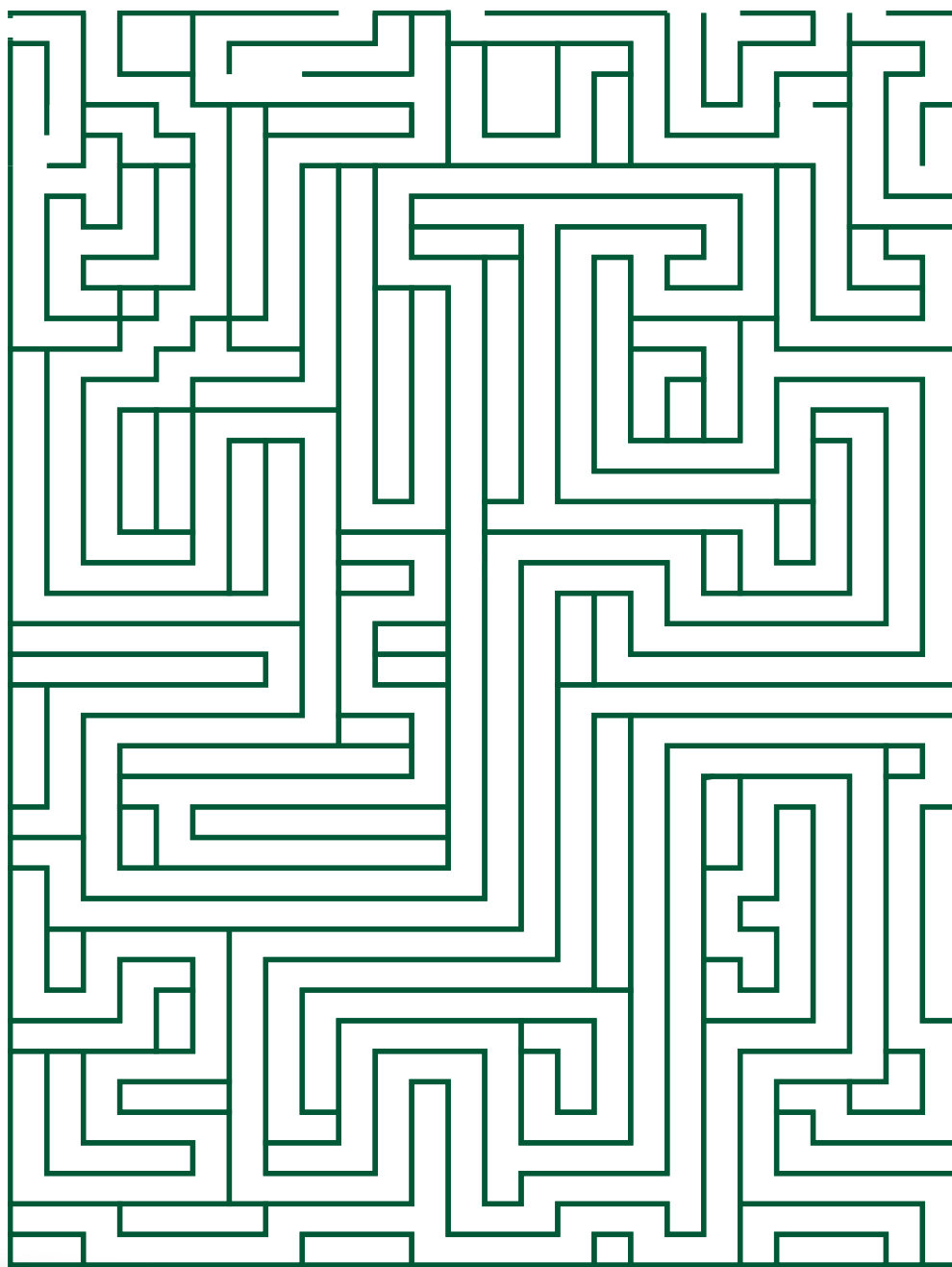

San José: Padre Amado

Une los puntos y posteriormente colorea.

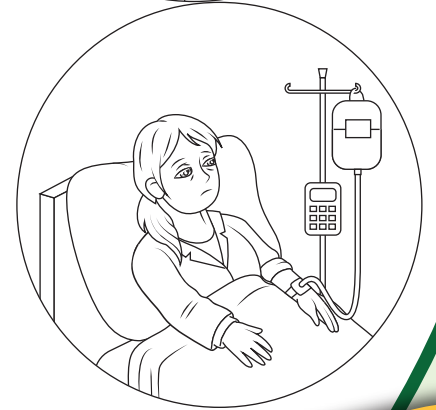
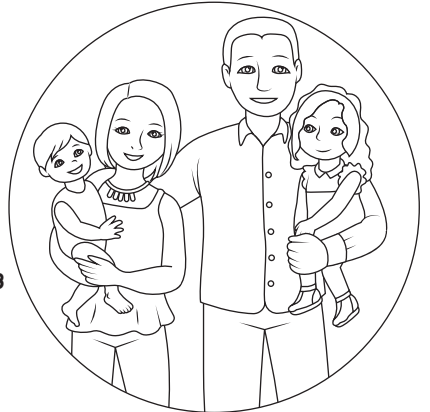
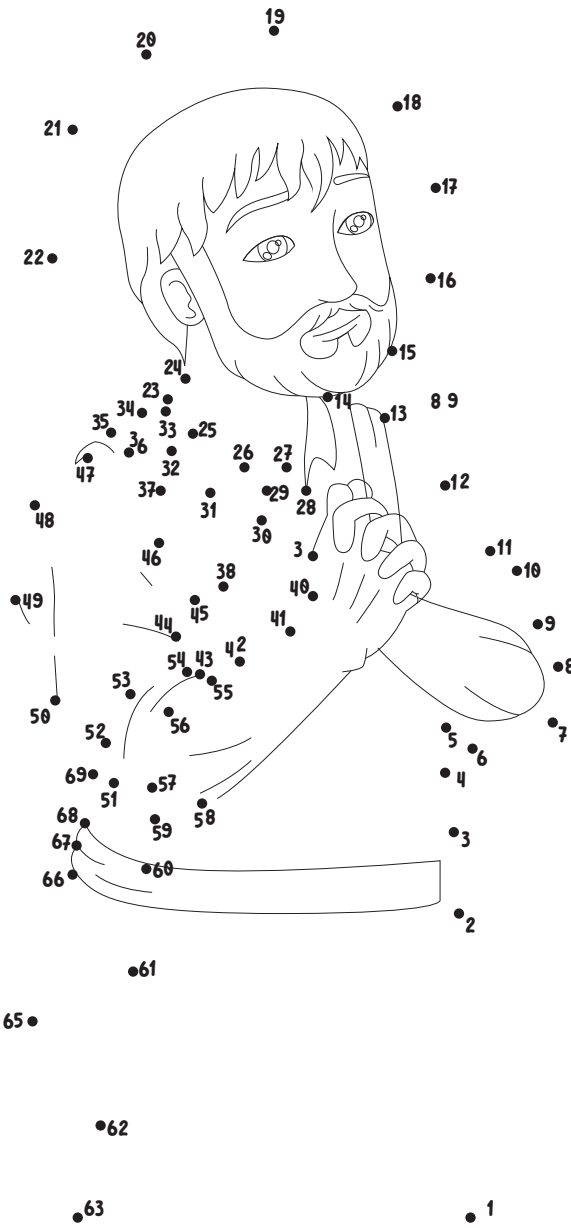
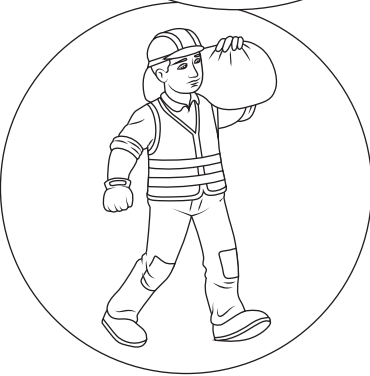

El amor de San José se manifestó al haber hecho de su vida un servicio y una entrega a la misión a la cuál fue designado por Dios el cuidar a la Sagrada Familia. Es un padre que siempre ha sido amado por el pueblo cristiano. (cfr. PC 1)



San José: Padre en la Obediencia

Encuentra el camino para que San José, la Virgen María y el Niño Jesús puedan llegar a Egipto.

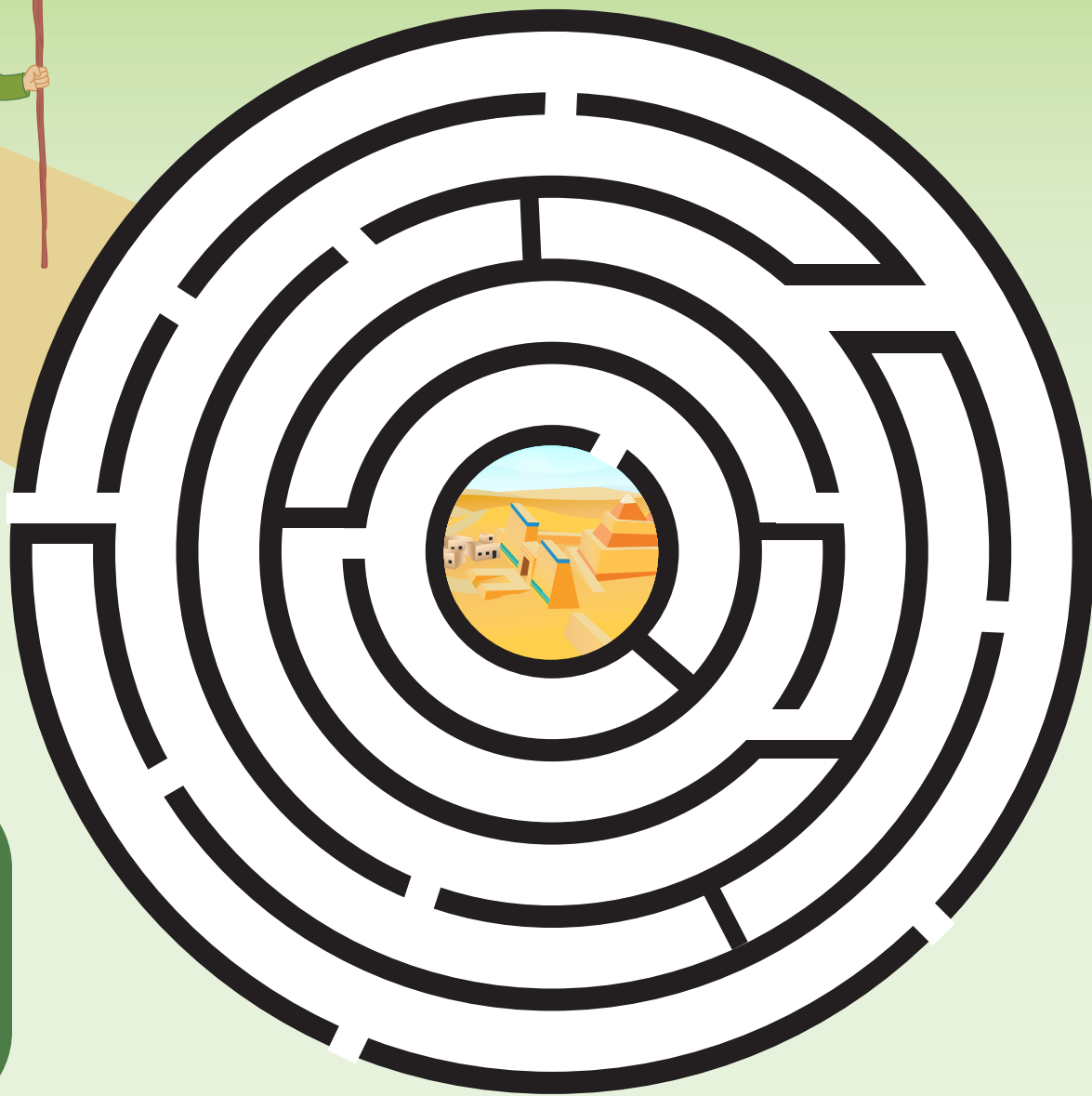

San José,
respondió a lo que
el Señor le pedía,
de una manera
verdaderamente
maravillosa e
incomparable.
(Papa Pío XI)



San José: Padre de la Valentía Creativa
Completa la imagen uniendo los puntos y colorea.



Sé siempre nuestro protector. Que tu espíritu interior de paz de silencio, de trabajo y oración al servicio de la Santa Iglesia.



San José: Padre del Silencio

Encuentra las 7 diferencias.



El silencio de San José no manifiesta un vacío interior, sino, al contrario, la plenitud de fe que lleva en su corazón y que guía todos sus pensamientos y sus actos.



San José: Padre Trabajador

Recorta las piezas y guíate con la imagen de referencia para armar y colorear el rompecabezas en la siguiente página.

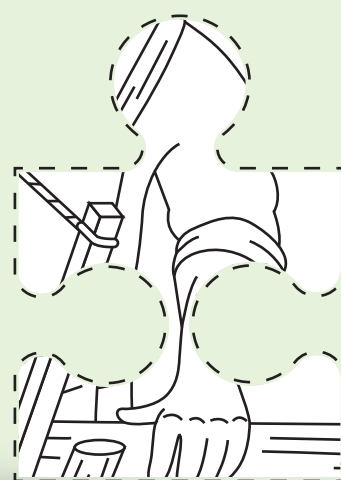
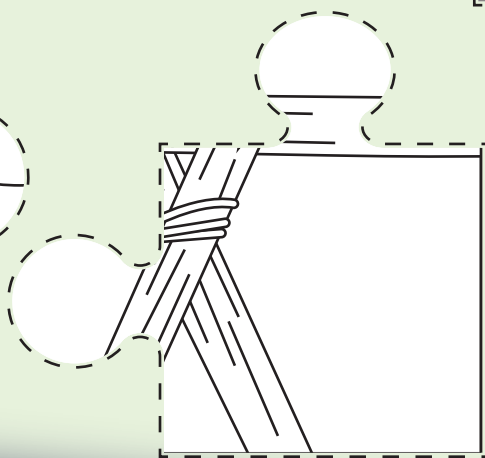
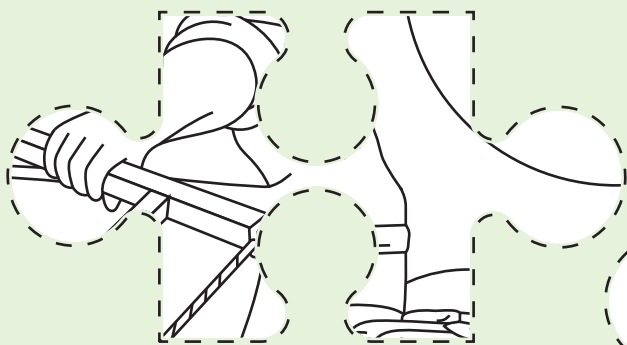
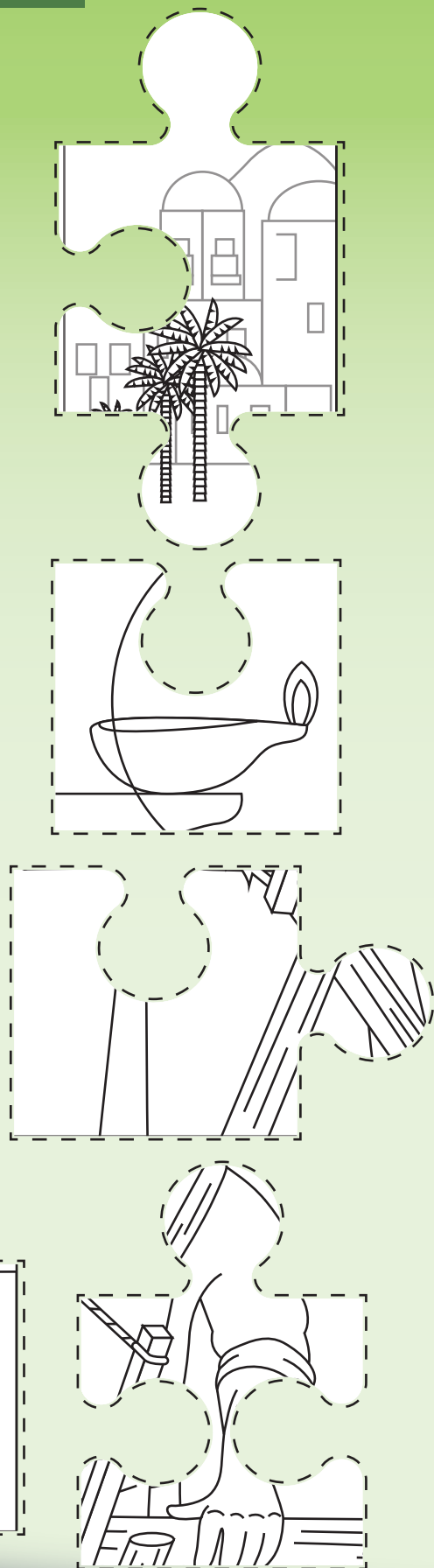

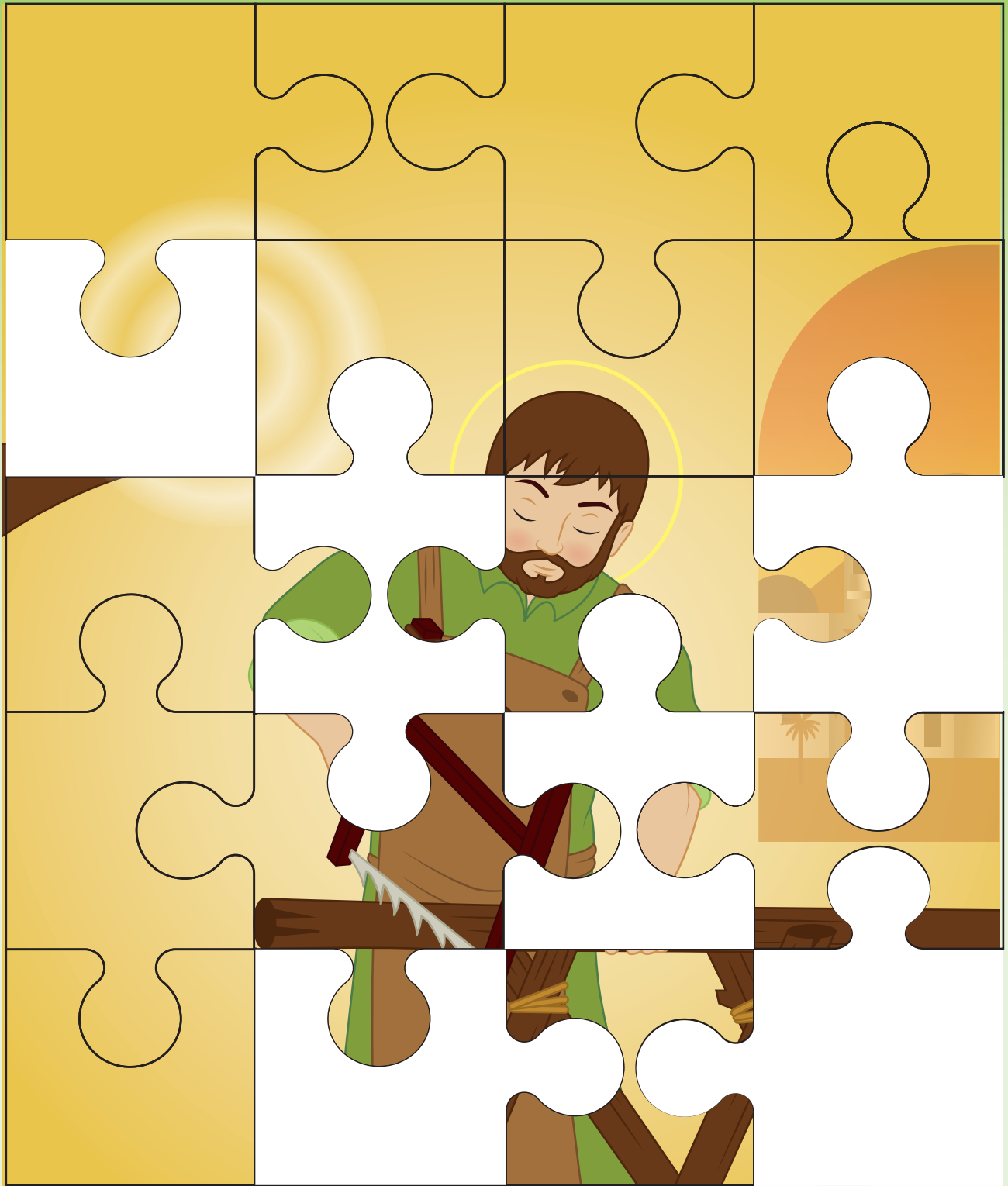

San José: Padre en la Sombra
Recorta y arma el rompecabezas pegándolo en otra hoja.



San José: Padre en la Sombra
Recorta y arma el rompecabezas pegándolo en otra hoja.

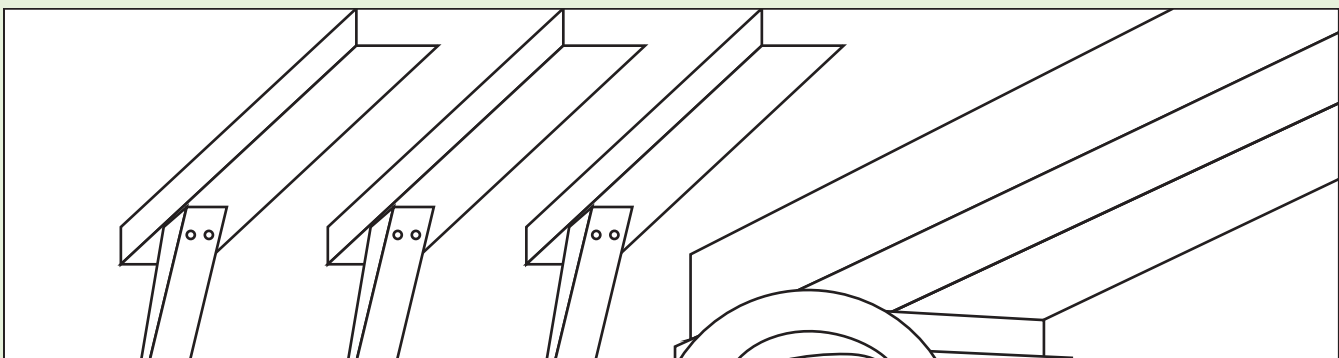

Memorama Virtudes de San José.

Recorta las cartas, dobla por la línea punteada y pega con pegamento de barra.



San José:
Padre protector



San José:
Con corazón de padre



San José:
Padre del silencio



San José:
Padre en la obediencia



San José:
Padre de la valentía creativa



San José:
Padre trabajador

Memorama Virtudes de San José.

Recorta las cartas, dobla por la línea punteada y pega con pegamento de barra.



San José:
Padre protector



San José:
Con corazón de padre



San José:
Padre del silencio



San José:
Padre en la obediencia



San José:
Padre de la valentía creativa



San José:
Padre trabajador

Memorama Virtudes de San José.

Recorta las cartas, dobla por la línea punteada y pega con pegamento de barra.

